



SUTTON

*Full Access Cabinetry*



April 2018, RiverRun Cabinetry added a Full Access cabinet line to their current framed cabinet offerings. This new line features two shaker door styles: **Sutton Sandstone** and **Sutton Driftwood** (pictured below) with a textured laminate finish and comes fully assembled.

## WHAT IS FULL ACCESS CABINETRY?

Frameless cabinetry is sometimes called “**Full Access**” cabinetry because it offers greater accessibility by eliminating the face frame. Instead, it relies on thicker box construction for stability. Only full overlay doors can be used, with hinges attached directly to the sides of the cabinet box. Full Access is common in Europe and often comes in more contemporary door styles.



Sutton Driftwood



Sutton Sandstone





## CONSTRUCTION

3/4" End Panels are utilized for finished look. These panels extend out, flush with drawer and door and to the floor, to create built-in look.

Full Access Construction with white melamine box

Undermount, full extension, soft-close glides

Soft-close hinges

Textured melamine laminate on both sides of a composite panel core

1/4" Applied toe kick

Drawer constructed with metal Legrabox system, white epoxy finish sides and 5/8" melamine bottom.

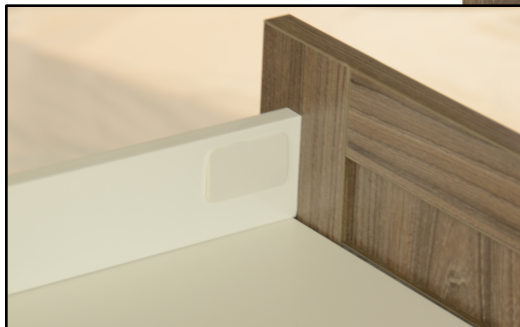



## TARGET CUSTOMERS

Full Access cabinets are great for any home, but it is especially helpful in certain environments and situations:

- **Small homes:** Frameless styles were first established in Europe where small housing is the standard. The structure allows for space savings when it really counts.
- **Multi-units:** Apartments, hotels, assisted-living and student housing are perfect for Full Access cabinetry. If cabinet faces become damaged due to abuse or heavy use, it is easier to simply change the doors and drawers rather than the entire cabinet. The same is true for updating to a fresh style.





## MIX & MATCH STYLES

It is no accident that RiverRun chose a shaker door style as their first design in the Full Access line.

Even though the frameless wall cabinets are 1" deeper, you can mix-n-match with our other shaker styles in the framed cabinets.

The wood textures in the Sutton line can offer a beautiful accent to some of our painted and stained shaker styles from our classic, framed cabinet line.



**Pictured above:** Dalton Gray kitchen with Sutton Driftwood island

**Right:** Bar featuring Sutton Sandstone trim with Sutton Driftwood panels





## END PANELS

End panels on Full Access Cabinets provides a modern, smooth look. Frameless cabinets with the edges of doors and drawers butted nearly flush provide an elegant, sleek look in a kitchen—a look that is impossible to achieve with framed cabinets where frames are always visible.

The white melamine box construction allows for space savings when it's really needed but exposed end cabinets will always need an end panel for a finished look.

All end panels are  $\frac{3}{4}$ " thick and extend out flush with the drawer and door fronts.

Base end panels extend to the floor and are not notched at the toe kick similar to high-end frameless cabinetry.

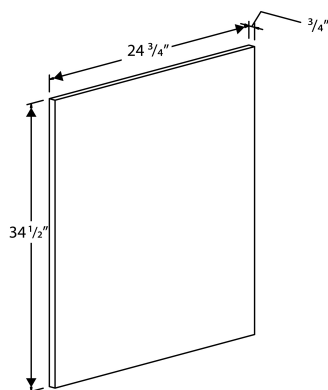

**Pictured above:** Sutton Driftwood island with installed end panel

**Pictured Right:** Sutton base cabinet without end panel on left side and installed end panel on right side

**Pictured Left:** Spec drawing for Base End Panel Vanity



## Care & Maintenance

With proper care, Sutton cabinets will maintain their beautiful color and texture for many years. Generally, a damp sponge is all you need for everyday maintenance of laminate surfaces.

### Basic Cleaning

Use a soft cloth to wash the surface with warm water and a mild dishwashing detergent. Rinse with warm water and dry with a soft cloth. Use an all-purpose cleaner or bathroom cleanser to remove spots and stains.

Avoid harsh chemicals and abrasives to keep the textured surface looking beautiful for many years to come.



## PRODUCT SPECS & NOTES

### CASE

- White melamine box that utilizes end panels for a finished look. End panels are 3/4" thick.

### DOOR/DRAWER REVEALS

- Wall cabinet doors have a 1/16" reveal on all sides. 1/8" between doors.
- Base cabinet doors have a 1/16" reveal on all sides. 1/8" between double doors and between doors/drawers.

### DOOR CLEARANCE

- As with all full access door styles, clearance of doors and drawers must be taken into consideration during the design process to assure proper operation of all doors and drawers.





### SINGLE DOOR CABINET HINGING

- Single Door Cabinets are universally hinged on the right side. These doors may be reversed in the field as needed.



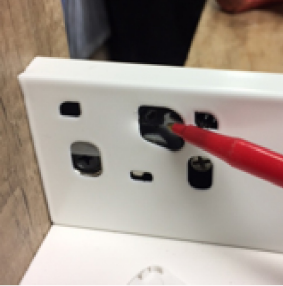

## EASY TO REPAIR. EASY TO CHANGE DRAWER FRONTS.

<p><b>1</b></p>  <p>Remove rectangle cover from inside the drawer. (do this on both sides of the drawer box)</p>	<p><b>2</b></p>  <p>Lift black tab with a number 2 screw driver.</p>	<p><b>3</b></p>  <p>Insert the screwdriver in the phillips socket behind the black tab.</p>	<p><b>4</b></p>  <p>Rotate screwdriver towards the back of the drawer. This will release the drawer front.</p>	<p><b>5</b></p>  <p>After releasing the second clip the front can be gently slid away from the drawer box.</p>
---	---	---	---	---



## Sutton Full Access Product Training Completion Acknowledgement

I acknowledge that I received training on the RiverRun Sutton product line and agree that:

- I have viewed the provided information on Sutton and Full Access Cabinets and have a better understanding of this product.
- The Sale Rep was informative and answered my questions.
- I understand I am eligible for a Free Sutton Display for our showroom.
- If I have further questions, I understand I can reach out to my Sales Rep or call RiverRun Customer Service at: 540-438-5973.

Sales Rep Name: \_\_\_\_\_

Dealer Name: \_\_\_\_\_

Dealer's Signature: \_\_\_\_\_

Company Name: \_\_\_\_\_

Date: \_\_\_\_\_

Please scan and return to:

CustomerService@RiverRunCabinetry.com or Fax: 540.438.1992

## *Certificate for a* **FREE Sutton Showroom Display**

This certificate entitles

\_\_\_\_\_

to a Free Display of Sutton Full Access Cabinets.

The bearer of this certificate acknowledges the following:

1. A list of cabinets and display layout must be sent to your RiverRun Sales Rep for approval before submitting the order to RiverRun.
2. Approved orders must be placed using the RiverRun Online Order system at <https://orders.riverruncabinetry.com>. Please type "Free Sutton Training Display" in the comments section on the order site.
3. Display is for SHOWROOM use only and must be installed within 30 days of receiving cabinets. An invoice will be sent when the order is shipped, but not due for 35 days. If cabinets are not installed within 30 days of shipment, the invoice will be due.
4. A picture of the installed cabinets in the showroom must be sent to Carol Swinehart at [cswinehart@classicdistribution.us](mailto:cswinehart@classicdistribution.us). (Please note if this step is not completed within 30 days of receiving the cabinets, the bearer of this certificate will be responsible for paying the display invoice.)

